

GCM-910402M

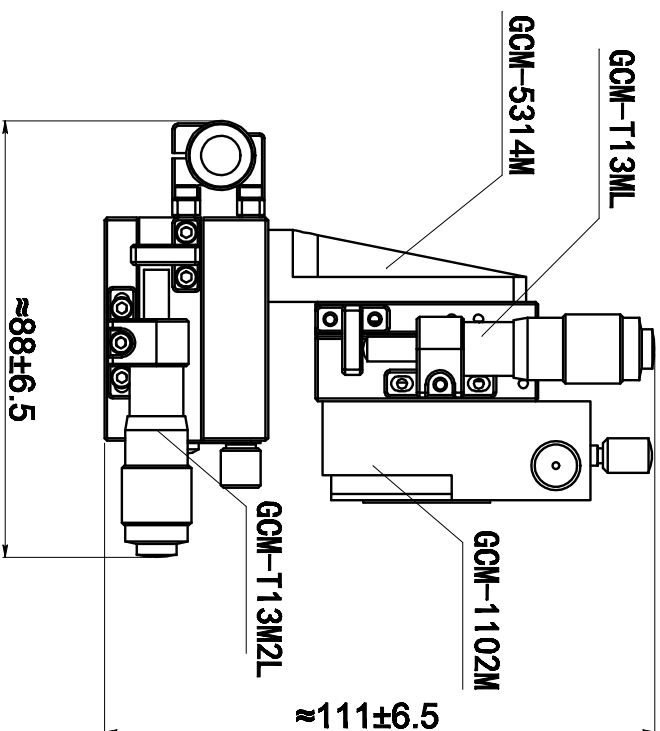
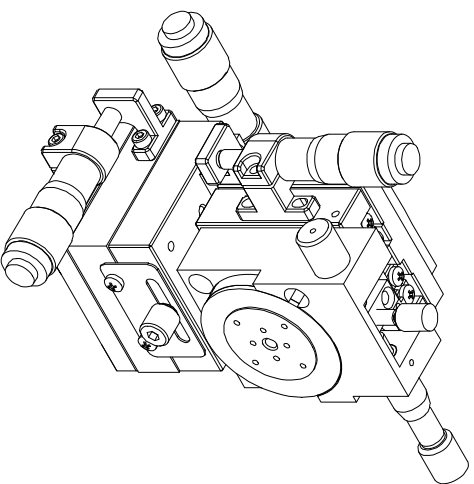
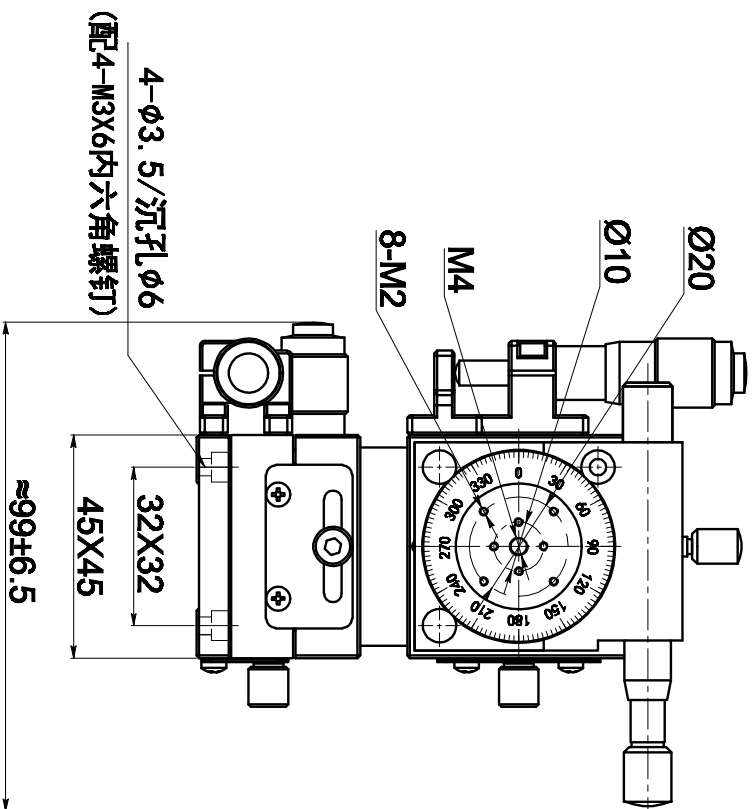

组合产品	数量	行程X (mm)	行程Y (mm)	行程Z (mm)	旋转 (°)
GCM-T13M2L	1	± 6.5	± 6.5	—	—
GCM-T13ML	1	—	—	± 6.5	—
GCM-1102M	1	—	—	—	360°
GCM-5314M	1	直角底座			