

GCM-901602M

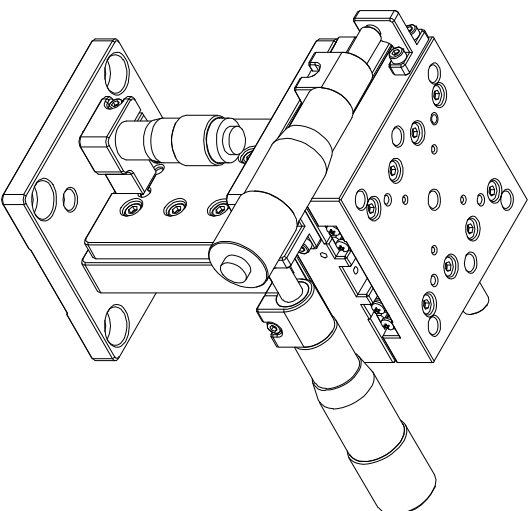
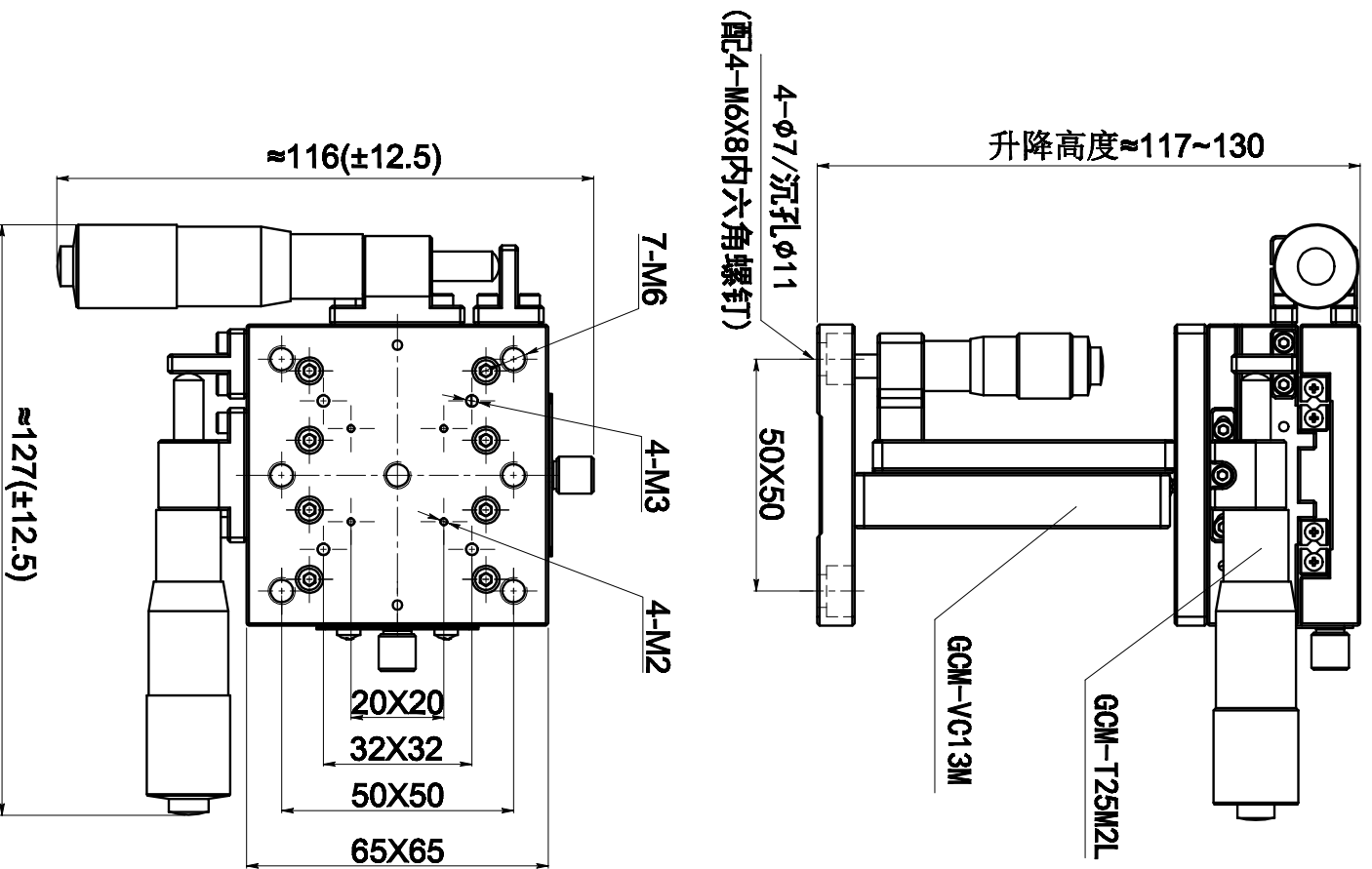

组合产品	数量	行程X (mm)	行程Y (mm)	行程Z (mm)
GCM-T25M2L	1	±12.5	±12.5	—
GCM-VC13M	1	—	—	0-13